

# Guideline

## Environmental Protection Act 1994

### Approval processes for environmental authorities

*This guideline outlines the different processes for applying for and managing an environmental authority for an environmentally relevant activity. This document provides guidance on the statutory processes under the Environmental Protection Act 1994 related to environmental authorities for both prescribed environmentally relevant activities and resource activities.*

#### Table of contents

1. Introduction .....	3
2. Applying for a new EA .....	4
2.1 Types of applications .....	4
2.2 Which stages apply for different applications and activities .....	4
2.3 Application stage .....	5
2.4 Information stage .....	7
2.5 Notification stage .....	9
2.6 Decision stage .....	11
2.7 Differences where a voluntary EIS has been completed .....	13
2.8 Differences where an EIS is required .....	14
3. Registration of a suitable operator.....	16
4. When an EA takes effect .....	17
5. Amendment of an EA (by application) .....	17
5.1 Assessment level decision .....	18
5.2 Minor amendment (threshold) .....	18
5.3 Minor amendment (condition conversion) .....	19
5.4 Major amendment .....	19
5.5 Amendment of condition requiring compliance with eligibility criteria .....	20
5.6 Public notification for a major EA amendment related to a resource activity .....	21
6. Amalgamation of EAs .....	21
7. De-amalgamate an EA .....	23
8. Transfer of an EA for prescribed ERAs .....	25
9. How an EA for a resource activity is transferred .....	26



10. Surrender of an EA .....	27
11. Suspension of an EA (by application) .....	29
12. Amendment of an EA (by the administering authority) .....	30
13. Cancellation or suspension of an EA (by administering authority) .....	31
14. Cancellation or suspension of a suitable operator registration .....	33
15. Internal review of decisions and appeals .....	34

### Table of figures

Figure 1: Application stage .....	6
Figure 2: Information stage .....	8
Figure 3: Notification stage .....	9
Figure 4: Combined public notification for an EA application for a mining lease .....	11
Figure 5: Decision stage .....	12
Figure 6: Decision stage for an EA application for a mining lease .....	13
Figure 7: Information stage where an EIS is required .....	15
Figure 8: Public notification where an EIS is required .....	16
Figure 9: Registered suitable operator application process .....	16
Figure 10: EA amendment application process .....	19
Figure 11: Process where applicant seeking to amend condition requiring compliance with the eligibility criteria .....	21
Figure 12: EA amalgamation application process .....	22
Figure 13: EA de-amalgamation application process .....	24
Figure 14: EA transfer application process for prescribed ERAs .....	25
Figure 15: EA transfer process for resource activities .....	26
Figure 16: EA surrender application process .....	27
Figure 17: EA suspension application process .....	29
Figure 18: EA amendment process by the administering authority .....	30
Figure 19: EA cancellation or suspension process by the administering authority .....	32
Figure 20: Cancellation or suspension of a suitable operator registration .....	33

## 1. Introduction

An environmentally relevant activity (ERA) is an activity (s. 18 of the EP Act) that is:

- an agricultural ERA defined under s. 75;
- a resource activity defined under s. 107;
- an activity prescribed under s. 19 as an ERA (i.e. prescribed ERA).

To carry out a prescribed ERA or a resource activity (referred to as ERAs in this guideline) an environmental authority (EA) is required under the *Environmental Protection Act 1994* (EP Act).

A prescribed ERA is one prescribed under Schedule 2 of the Environmental Protection Regulation 2019 (EP Reg). A resource activity includes:

- a geothermal activity; or
- a greenhouse gas storage activity; or
- a mining activity; or
- a petroleum activity.

Certain prescribed ERAs can be authorised under an EA for a resource activity. An activity that is a prescribed ERA can be authorised under an EA for a resource activity if the activity forms part of the resource activity (i.e. the prescribed ERA is an ancillary activity under section 19A of the EP Act). Ancillary activities are activities which are listed in Schedule 2 of the EP Reg and are carried out as part of the resource activity.

Ancillary activities are taken to be resource activities for the purpose of an application for an EA. For example, where a mining activity includes a prescribed ERA such as chemical storage, this prescribed ERA is taken to be an ancillary activity of the mining activity and can be included in the one EA application.

However, for the purpose of imposing conditions on an EA, ancillary activities are taken to be prescribed ERAs rather than resource activities. This approach ensures consistency when imposing conditions on an EA for prescribed ERAs that are undertaken on tenure (as ancillary activities of a resource activity) and prescribed ERAs that are undertaken off tenure.

The processes for applying for and managing an EA for an ERA are primarily specified in Chapter 5 of the EP Act. Chapter 5, Parts 2 to 5, of the EP Act specify the EA assessment process, with each Part relating to a different stage, i.e. application stage (Part 2), information stage (Part 3), notification stage (Part 4), and decision stage (Part 5). Chapter 5 contains the 'post approval' processes for amending, amalgamating, de-amalgamating, transferring and surrendering, suspending or cancelling an EA already held. The process for registering as a suitable operator is found in Chapter 5A and the internal decision review process is found in Chapter 11. All references to section numbers are sections of the EP Act unless otherwise indicated.

In cases where carrying out a prescribed ERA requires a development permit, the development application is taken to be an EA application under s. 115 and processes under the *Planning Act 2016* (Planning Act) apply. This guideline addresses the processes under the EP Act only and not those under the Planning Act.

Updates to this guideline will be carried out periodically in line with any changes to relevant legislation. Where any discrepancy is found between this guideline and the EP Act, the EP Act prevails.

The Director-General of the Department of Environment, Science and Innovation (DESI) is the chief executive of the EP Act and administering authority for a majority of ERAs. However there are a number of prescribed ERAs which are devolved to local government or delegated to the Department of Agriculture and Fisheries (DAF). For more information on those prescribed ERAs administered by local government or DAF please refer to the Queensland Government website [www.qld.gov.au](http://www.qld.gov.au) using search terms 'ESR/2015/1662' and 'ESR/2015/1671' respectively.

This guideline indicates when a fee is payable without specifying the fee amount. The fee details can be found in the information sheets 'Fees for permits for environmentally relevant activities (ERAs)' (for application fees) and 'Summary of fees for environmentally relevant activities (ERAs)' (for annual fees) available at [www.qld.gov.au](http://www.qld.gov.au) using search terms 'ESR/2015/1721' and 'ESR/2015/1746' respectively.

## 2. Applying for a new EA

### 2.1 Types of applications

There are three different types of applications for a new EA; standard, variation and site-specific.

ERA standards have been developed for low risk activities. An ERA standard consists of eligibility criteria and standard conditions. A standard EA application is made for eligible ERAs that are subject to an ERA standard. An eligible ERA is defined in s. 112 as an ERA that complies with the eligibility criteria in effect for the activity and that is not carried out as part of a coordinated project. For further information on those ERAs which have standard conditions and eligibility criteria please refer to the Business Queensland website ([www.business.qld.gov.au](http://www.business.qld.gov.au)) and use the search term 'applying for an environmental authority'.

A variation application is made for an EA where the applicant is seeking a variation to the standard conditions and where all proposed ERAs are eligible ERAs.

A site-specific application is made where any of the proposed ERAs are not eligible ERAs and the EA is to be subject to conditions which are specific to the site. Model conditions which have been developed for specific industries will be applied where appropriate and/or any other conditions which are required or considered necessary or desirable by the administering authority. A site specific application may also relate to trial technologies which are proposed to conduct research into, or test, technology or processes relating to a prescribed ERA. These may be issued for no longer than 3 years and have reduced application requirements.

### 2.2 Which stages apply for different applications and activities

#### Standard application for a mining lease

- Application stage (see section [2.3](#))
- Notification stage (see section [2.5](#))
- Decision stage (see section [2.6](#))

#### Standard application for all prescribed ERAs and resource activities other than a mining lease

- Application stage (see section [2.3](#))
- Decision stage (see section [2.6](#))

#### Variation application for a mining lease

- Application stage (see section [2.3](#))
- Information stage (see section [2.4](#))
- Notification stage (see section [2.5](#))
- Decision stage (see section [2.6](#))

#### Variation application for all prescribed ERAs and resource activities other than a mining lease

- Application stage (see section [2.3](#))
- Information stage (see section [2.4](#))
- Decision stage (see section [2.6](#))

**Site-specific application for all resource activities (including a mining lease)**

- Application stage (see section [2.3](#))
- Information stage (see section [2.4](#))
- Notification stage (see section [2.5](#))
- Decision stage (see section [2.6](#))

**Site-specific application for all prescribed ERAs**

- Application stage (see section [2.3](#))
- Information stage (see section [2.4](#))
- Decision stage (see section [2.6](#))

For applications where a voluntary environmental impact statement (EIS) has been completed under Chapter 3, please see section [2.7](#) for further information on differences to EA stages and processes.

For applications where an EIS is deemed to be required, please see section [2.8](#) for further information on the differences to EA processes.

## 2.3 Application stage

The first stage of the assessment process for all EA applications is the application stage. During this stage the application is checked to ensure it is able to be made as per ss. 116–124 and properly made under ss. 125–127.

The end of the application stage is the earlier of:

- (i) 10 business days after receipt of the application; or
- (ii) such time the administering authority is satisfied that the application stage has been complied with.

If an application is not properly made, a ‘not properly made application notice’ is issued to the applicant under s. 128. This notice gives the applicant a period of 20 or more business days to take the required action stated within the notice for the application to be deemed properly made. If the required action is not taken within the stated period, the application then lapses.

The next assessment stage for an EA application is dependent on what type of application has been made and for what type of activity. For example, a standard application not related to a mining lease progresses directly to the decision stage, whereas a standard application for a mining lease, will progress to the notification stage.

### 2.3.1 Changing or withdrawing an EA application

An applicant may:

- make a minor change or agreed change to their application at any time before the decision is made without stopping the assessment process (ss. 131–133)
- make another change to their application (not minor and with no agreement) any time before the decision is made, which affects the assessment process (ss. 132, 134)
- withdraw their application at any time before the EA is issued by giving written notice (s. 135).

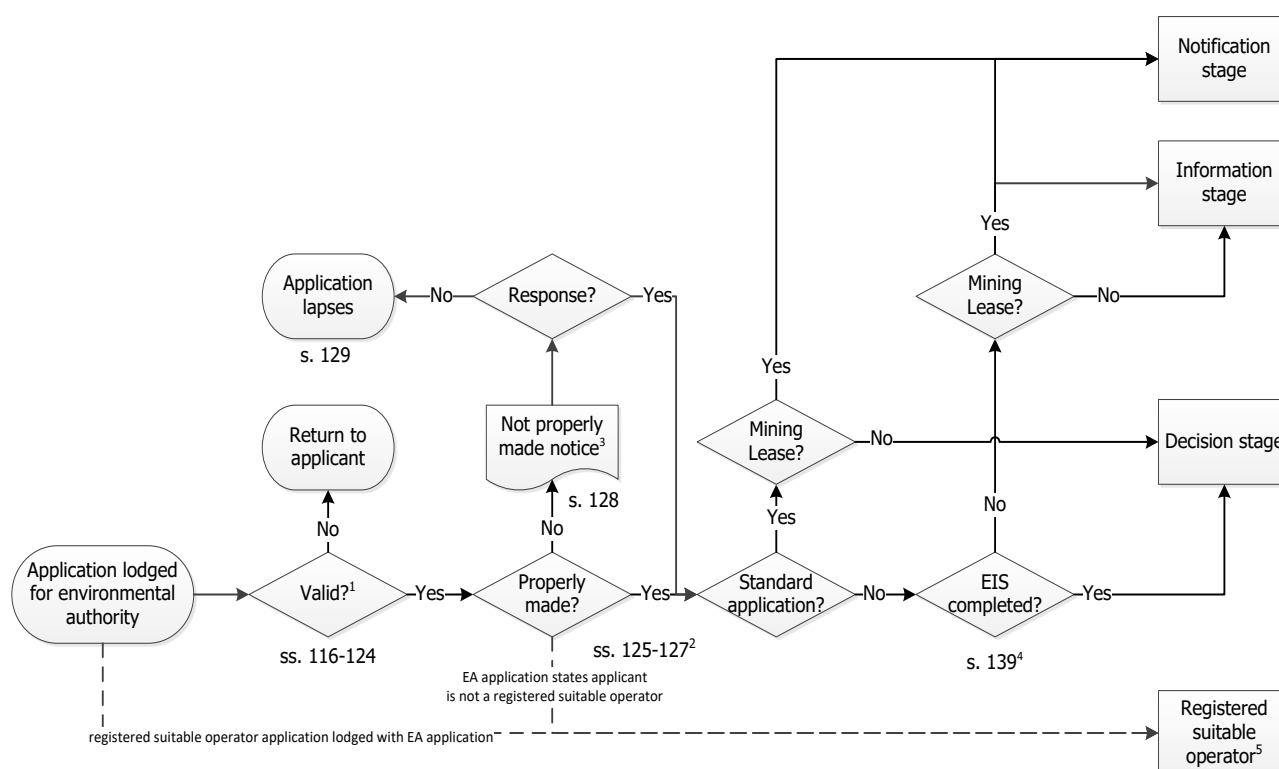

Figure 1: Application stage

**Notes:****<sup>1</sup> Valid application**

The application must:

- be made by a valid person (s. 116)
- for resource activities, be made by the person who has applied for relevant tenure (s. 117)
- be for an activity which is not part of a project with an existing EA (ss. 118 and 119)
- be for an activity which is an existing lawful use of the land (s. 120)
- meet the requirements of ss. 122–124 for the relevant application type.

**<sup>2</sup> Properly made application**

The application must

- meet the application requirements (s. 125)
- for a standard or variation application, include a declaration stating compliance with the eligibility criteria (s. 125)
- for a coal seam gas activity, contain the mandatory information (s. 126).

**<sup>3</sup> Assessment timeframes**

- A 'not properly made application notice' can only be issued within 10 business days after the administering authority receives the application (s. 128).
- The applicant must have at least 20 business days to respond (s. 128).
- The application lapses if the applicant does not give written notice that the required action has been taken within the stated period (s. 129).
- For a properly made application, the application stage ends the earlier of:
  - 10 business days after the application is received by the administering authority OR
  - if the administering authority is satisfied that the requirements of the application stage have been complied with OR

- Where a 'not properly made application notice' is issued, the application stage ends the day the administering authority receives written notice that the required action has been taken (s. 136).

#### **4 Completed EIS process**

The information stage does not apply if:

- an EIS has been completed under Chapter 3 of the EP Act for each relevant activity the subject of the application and the EIS assessment report relating to each relevant activity has not lapsed under section 59A; or
- in evaluating an EIS under the *State Development and Public Works Organisation Act 1971* (State Development Act), the Coordinator-General has stated conditions that relate to each relevant activity the subject of the application; and
- for an EA -the environmental risks or the way that the activity will be carried out have not changed since the EIS was completed; or
- for a proposed PRC plan – there is no change in a PMLU or NUMA, or to the impacts on environmental values that achieving or managing these areas will have, compared to impacts under the EIS; achieving a stable condition for land has not changed; and the day by which rehabilitation of land to a stable condition will be achieved has not changed,(s. 139).

The notification stage does not apply if:

- an EIS (including a proposed PRC plan where applicable) under Chapter 3 of the EP Act or the State Development Act, has been notified; and
- the environmental risks have not changed since the EIS was completed; or
- if the application proposes a change, is deemed unlikely to attract a submission about the change
- for a proposed PRC plan, there is no change in a PMLU or NUMA or the day by which rehabilitation of land to a stable condition will be achieved (s. 150).

#### **5 Registered suitable operator**

The administering authority must refuse the EA application if the applicant is not a registered suitable operator. An application to become a registered suitable operator may be made before the EA application is made, or together with the EA application.

## **2.4 Information stage**

The information stage applies to all variation or site-specific EA applications. During this stage the application is checked to see whether sufficient information has been provided to decide the application. If so, the application can proceed to the next assessment stage. For variation applications the information request period is 10 business days after the application stage ends, for site-specific applications the information request period is 20 business days<sup>1</sup>, and for site-specific applications accompanied by a proposed progressive rehabilitation and closure plan (PRC plan) the information request period is 30 business days. If sufficient information has not been provided an information request notice can be issued to the applicant within the information request period, requesting the applicant supply the missing information. If there is no proposed PRC plan for a site-specific application for a mining activity relating to a mining lease, the information request must include a requirement that the applicant submit a proposed PRC plan for the application. The information request period

---

<sup>1</sup> Under section 144(a) of the EP Act, for site-specific applications for a mining activity relating to a mining lease where a proposed PRC plan does not accompany the application, an information request must be made within:

- if a proposed PRC plan is submitted before the period mentioned in section 143(a)(ii) – 30 business days after the day the application ends for the application; or
- if a proposed PRC plan is submitted after the end of the period mentioned in section 143(a)(ii) – 10 business days after the proposed PRC plan is submitted.

may be extended once by written notice by the administering authority or further extended by agreement with the applicant.

If an information request notice is issued, the applicant will need to respond within the response period stated in the notice. This period must be at least six months after the notice is given. The applicant may ask the administering authority to extend the response period, however this request must be made at least 10 business days before the response period is due to end. Where an extension request has been received, the administering authority must decide whether to approve the extension to the response period and issue a notice of extension decision within five business days after receiving the request.

If the administering authority does not receive a response to the information request notice within the period stated in the notice or a further agreed period, the application then lapses. The information stage ends when:

- if an information request is made—a response is received that meets the requirements under s. 146.
- if an information request is not made, the earlier of the following:
  - when the administering authority decided not to make an information request; or
  - the information period, including any extensions, has ended.

Figure 2 outlines the main steps for the information stage.

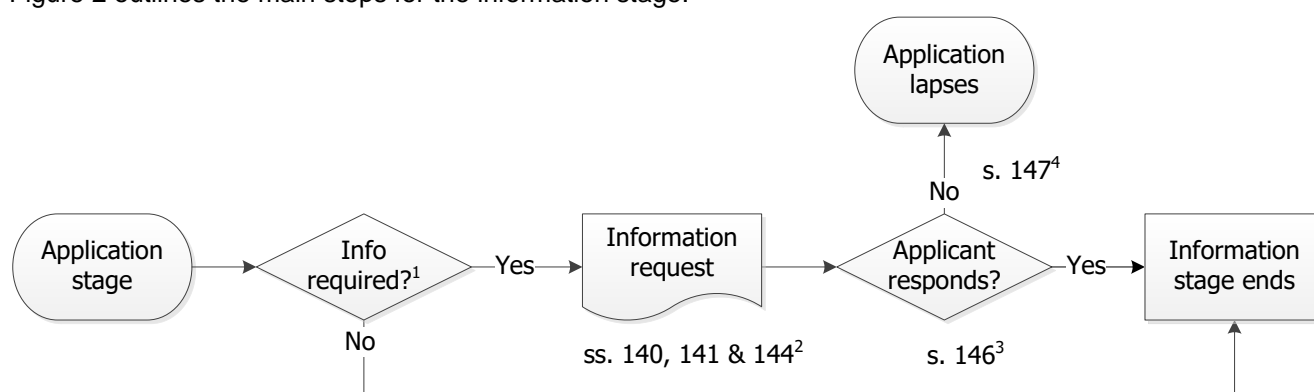

**Figure 2: Information stage**

### **Notes:**

#### **¹Assessment of application**

To identify if information is required the assessing officer will review the information contained in the application against the matters that must be considered under the regulatory requirements (in ss. 30-41 of the EP Reg) and the Standard Criteria (defined in Schedule 4 of the EP Act).

#### **² Assessment timeframes**

An information request must be made within:

- 30 business days for a site-specific application accompanied by a proposed PRC plan
- 20 business days for a site-specific application<sup>1</sup>
- 10 business days for a variation application (s. 144).

The period may be extended by the administering authority through written notice.

The response period must be stated in the information request. The period must be at least six months after giving the information request (s. 141).

#### **³Responding to the information request**

The applicant must respond by:

- giving all of the information requested; or



## Approval processes for environmental authorities

- part of the information requested together with a written notice asking the administering authority to proceed with the assessment of the application; or
- a written notice:
  - (i) stating that the applicant does not intend to supply any of the information requested; and
  - (ii) asking the administering authority to proceed with the assessment of the application
- if the information request requires the applicant to submit a proposed PRC plan for the application—submitting a proposed PRC plan complying with part 2, division 3 of the EP Act (s.146).

#### <sup>4</sup> Application lapsing

The applicant may request to extend the response period. The application lapses if a response to the information request is not provided within the information response period (s. 147).

## 2.5 Notification stage

The notification stage applies to all EA applications related to a mining lease, and site-specific applications for a petroleum, geothermal or greenhouse gas storage activity. The notification stage may start at any time after the application stage ends and may proceed concurrently with the information stage where it applies<sup>2</sup>.

Figure 3 below outlines the steps within the notification stage. This includes the acceptance of submissions about the application and the applicant's responsibility to lodge a declaration of compliance to the administering authority declaring that the relevant public notification requirements have been complied with. Once the requirements have been met, or the administering authority decides that applicant has substantially complied with the requirements and issued a notice under s. 159 confirming this decision, the notification stage ends.

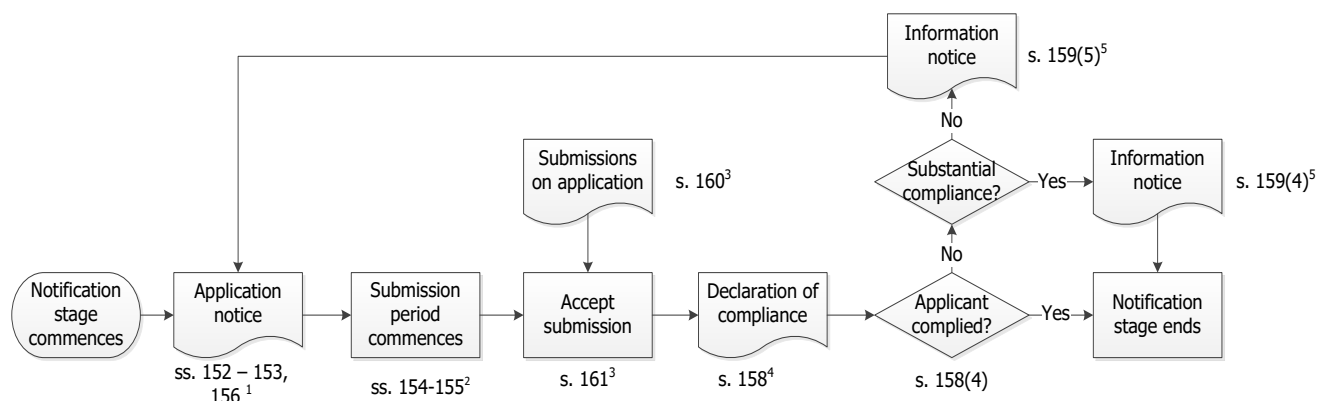

Figure 3: Notification stage

#### Notes:

##### <sup>1</sup> Application notice requirements

- The applicant must give and publish an application notice in a newspaper circulating in the area of the proposed activity before 10 business days after the end of the information stage (s. 152).
- If public notice is required under resource legislation, the application notice must be in the same way and together with the application notice for the resource tenure application (see next section).
- For site-specific applications the applicant must keep the application notice and application documents on a website. This information must be made available until the application is decided, withdrawn or lapsed (s. 156).

<sup>2</sup> If the application is a site-specific application for a mining activity relating to a mining lease, the applicant may start the notification stage only if there is a proposed PRC plan for the application.

**<sup>2</sup> Submission period**

For applications not related to a mining activity the period cannot end before a day or time fixed by the administering authority or 20 business days after the application notice is published (s. 155).

The submission period for an application related to a mining activity ends on the last objection day under the *Mineral Resources Act 1989* for the application (s. 154) (see next section).

**<sup>3</sup> Submissions**

A person may make a submission on an application or a proposed PRC plan for the application within the submission period (s. 160). The person who made the submission may amend or replace their submission (s. 162).

The administering authority must accept a submission that is properly made and may accept any other submissions even if they are not properly made (s. 161).

**<sup>4</sup> Declaration of compliance**

The applicant must give the administering authority a statement regarding whether or not they have complied with the public notice requirements (s. 158).

**<sup>5</sup> Substantial compliance**

If the applicant:

- has not complied with the public notice requirements, the administering authority must decide whether the applicant has substantially complied with the requirements
- has not substantially complied, the administering authority must set a substitute way for notification
- has substantially complied, the administering authority may allow the application to proceed (s. 159).

**2.5.1 Combined public notification of an EA application related to a mining lease**

For all EA applications for a mining lease, the application notice must be given and published simultaneously, or together with, the public notice for the resource tenure application. This means that the public notification for the resource tenure application and the EA application occurs at the same time.

The combined notification process is coordinated by the administering authority for the *Mineral Resources Act 1989* (MR Act) (currently the Department of Resources (DOR)). DOR issues the certificate of public notice under s. 252A of the MR Act once public notification may commence and the EA application is confirmed as properly made. The applicant then publishes a combined application notice for the resource tenure and EA applications using the template provided by DOR. The submission period for the EA application ends on the last objection day/s for the relevant mining tenure/s. During this combined public notification process DOR carry out the following actions on behalf of DESI:

- receive any submissions made for either the EA application
- receive the applicant's declaration of compliance that the public notification requirements have been complied with
- if a declaration of compliance is not received, determine whether the applicant has achieved substantial compliance and if so issue a notice to the applicant confirming this under s. 159
- if the applicant has not achieved substantial compliance, issue a notice fixing a new submission period and a substituted way to give or publish a new application notice
- once the notification stage has ended forward all submissions and any other EA related documentation to DESI for consideration during the decision stage

Figure 4 below illustrates how the combined public notification process is coordinated between DOR and DESI.

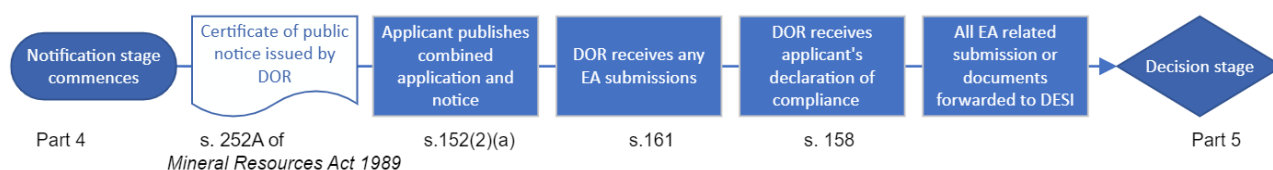

**Figure 4: Combined public notification for an EA application for a mining lease**

## 2.6 Decision stage

The decision stage for all EA applications begins the day all other stages have ended. This may apply at the end of the application stage, the information stage or the notification stage depending on which stages have applied to the application. The only exception to this is under s. 167 where the application is site-specific and relates to a coordinated project for which an EIS or Impact Assessment Report (IAR) was required under the *State Development and Public Works Organisation Act 1971 (SDA)*. If so, the decision stage commences on the later of:

- the day the Coordinator-General gives the proponent a copy of the Coordinator-General's report under the SDA
- the day all other stages applying to the application have ended.

A decision about the application must be made within 20 business days after the decision stage starts, or if the application is accompanied by a proposed PRC plan the decision must be made within 30 business days after the decision stage starts, although this period may be extended once by written notice from the administering authority or further extended by agreement with the applicant. If approved the administering authority must issue the EA to the applicant within five business days. Any submitter for the application must also be given a notice about the decision within 10 business days after the decision is made. In cases where a condition has been imposed on the EA which the applicant has not agreed to in writing, or the application is refused, a notice about the decision must be given to the applicant within 5 business days.

A standard application must be approved provided the applicant is a registered suitable operator, the EA application is properly made and all ERAs proposed to be carried out are eligible ERAs. A variation application must also be approved in these circumstances; however the approval may be for an EA with varied conditions, or the standard conditions (not varied) for the activity. Site specific applications can be either approved subject to conditions or refused; for site-specific applications accompanied by a proposed PRC plan, if the proposed PRC plan is refused the administering authority must also refuse the EA application.

Despite the above, there are some circumstances where an EA application must be refused regardless of its type. These circumstances are outlined in s. 173 and include matters such as where the applicant is not a registered suitable operator.

When deciding an EA application the administering authority must comply with criteria for decision under s. 175 – 176A, including any properly made submission about the application and the regulatory requirements found in ss. 30–41 of the EP Reg. The conditions that are imposed on the EA must meet the requirements under ss. 203–210 where applicable.

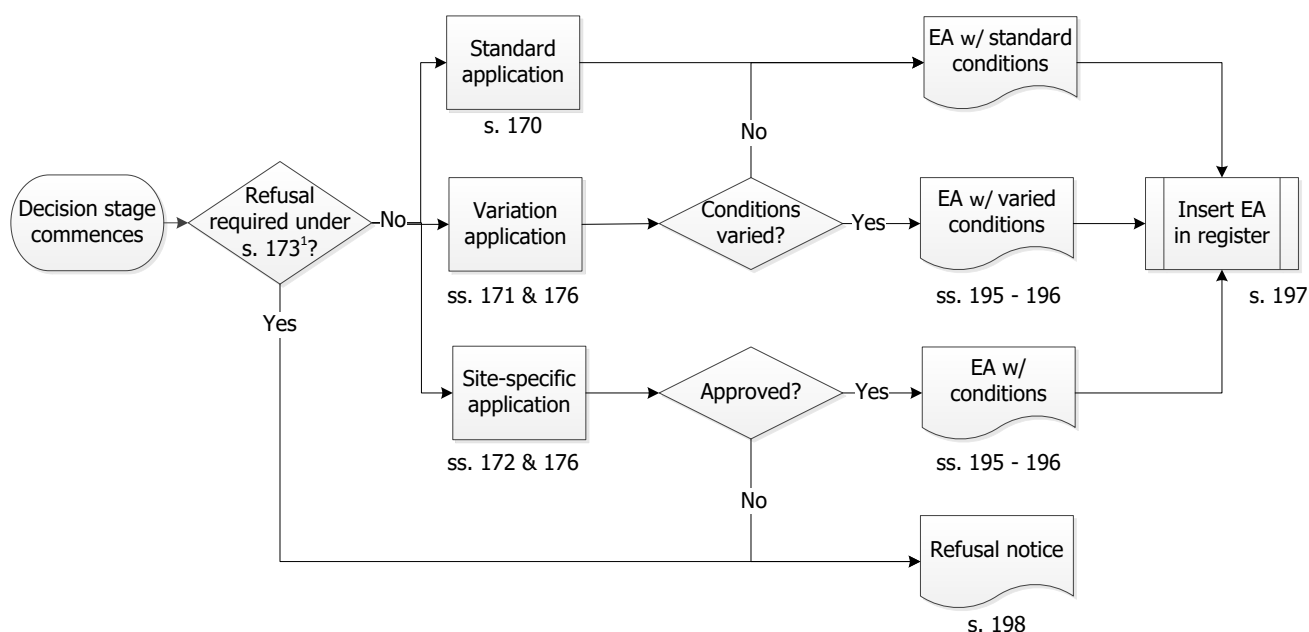

Figure 5: Decision stage

**Notes:****<sup>1</sup> Particular applications which must be refused (s. 173)**

Applications must be refused if:

- the applicant is not a registered operator
- the administering authority is the assessment manager or concurrence agency for a development approval application is considered to be an EA application under s. 115 and is either refusing the development application or giving a preliminary approval only. This will only apply where a local government is the administering authority.

**2.6.1 Decision stage for an EA application related to a mining lease**

The decision stage for an EA application related to a mining lease is slightly different to other activities. Once a decision is made for a mining lease, the applicant and any submitters (for submissions made during the preceding notification stage) will be provided a copy of the decision notice and a draft EA (if approved) within five business days.

If satisfied with the decision, the applicant is able to notify the administering authority that they do not intend to make a referral to the Land Court. Where there are no other submitters, this progresses the timeframes for issuing the EA, as we do not have to wait until the end of the s.181 notice period. If a notice is received the administering authority has 5 business days to issue the EA (s.196).

If unhappy with the decision, the applicant is able to request the application be referred to the Land Court and a submitter can request that their submission be taken to be an objection for the application, also requiring referral to the Land Court. This request by the applicant or objection by a submitter must be made within 20 business days after the draft EA is given.

The Land Court processes then commence and an objections decision is made. If after this process the EA is approved, the applicant will be issued the EA and details will be added to the EA register. If the application is refused the applicant will be provided with a refusal notice. Figure 6 outlines the decision stage, including Land Court referral, for an EA application related to a mining lease.

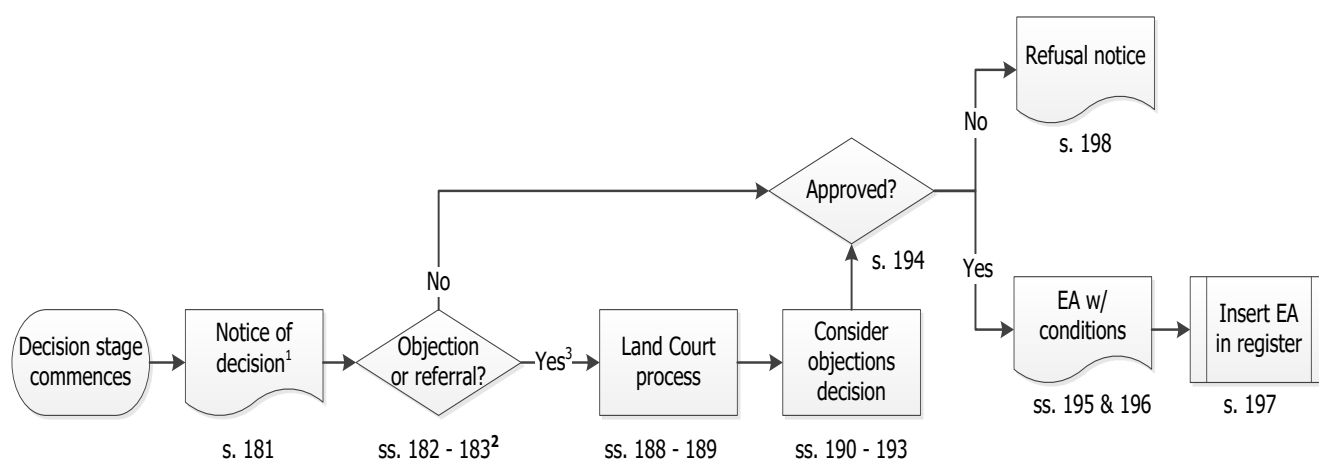

**Figure 6: Decision stage for an EA application for a mining lease**

### Notes:

#### **<sup>1</sup> Notice of decision and draft EA**

The administering authority must, within five business days of making a decision give the applicant and any submitters notice of the decision made and a copy of the draft EA (when approved) (s. 181).

#### **<sup>2</sup> Objections and referrals**

A submitter (from the notification stage) may give written notice that the submission is to be taken to be an objection to the application (s. 182). The applicant may give a written notice requesting the application be referred to the Land Court (s. 183). The applicant may also give a written notice advising that they have no intention of referring the application to the Land Court (s.183). This must be given to the administering authority within 20 business days after the notice of decision and draft EA (when approved) was issued. If there were no submitters to the application and a notice is received advising that no referral will be made by the applicant, the administering authority must issue the environmental authority within 5 business days after the applicant gives the written notice (s.196).

#### **<sup>3</sup> Referrals to the Land Court**

The administering authority must refer the application to the Land Court for a decision, 10 business days after the latter of either receiving the last objection notice or receiving a request for referral to the Land Court (s. 185). The administering authority must give the applicant a copy of the referral notice made to the Land Court, and a copy of the objection notice and the submission. Further, the administering authority must give any objector a copy of the referral notice made to the Land Court (s. 187).

## **2.7 Differences where a voluntary EIS has been completed**

For those resource activities for which a voluntary EIS has been completed under Chapter 3, the assessment stages and processes which apply to an EA application are different.

The information stage will not apply to the application where:

- the EIS process for an EIS covering all the relevant activities in the application has been completed; and the EIS assessment report relating to each relevant activity has not lapsed under section 59A; and
- the environmental risks of the activities and the way the activities will be carried out have not changed since the EIS was completed.

An EIS assessment report lapses on the day that is three years after the day the chief executive gives the proponent the EIS assessment report under section 57(2) or if the chief executive extends this period, on the day the extended period ends. However, if the proponent applies for an EA before the EIS assessment report lapses, the report does not lapse until -

- if the application for the environmental authority is refused—the application is decided and any appeal against the decision is finalised or withdrawn; or
- if the application for the environmental authority is granted—the authority takes effect.

The notification stage will not apply to the application where:

- the EIS process for all the relevant activities in the application was completed **before the application was made**; and
- the environmental risks of the activity have not changed since the EIS was completed; and
- if the application proposes a change to the way the relevant activity is to be carried out—the administering authority is satisfied the change would not be likely to attract a submission objecting to the thing the subject of the change, if the notification stage were to apply to the change.

During the decision stage, any properly made submissions made during the EIS process are taken to be properly made submissions for the EA application.

## 2.8 Differences where an EIS is required

After an EA application is made, an EIS may be deemed required for particular resource activities under ss. 143. Where an EA application requires an EIS to be completed under Chapter 3 of the EP Act, the information and notification stages for the application have some differences.

### 2.8.1 The information stage where an EIS is required

During the information stage for a variation or site-specific application, an information request notice is issued to the applicant by the administering authority which details the requirement to complete the EIS process. The EIS process is then carried out within the information stage for the EA application. The applicant has up to two years from when the final terms of reference are given under s. 46 (1) to complete the process or any longer period decided by the chief executive before the 2 years ends.

Under s. 49, the chief executive must consider the submitted EIS and within 20 business days (the decision period) decide to allow the submitted EIS to proceed under division 4, with or without conditions, or refuse to allow the submitted EIS to proceed. The chief executive may extend the decision period by up to 12 months if the proponent agrees in writing, and the chief executive has not previously extended the decision period. The chief executive may allow the EIS to proceed only if the chief executive considers it addresses the final terms of reference in an acceptable form. The chief executive must refuse to allow the EIS to proceed if satisfied it is unlikely the project could proceed under the EP Act or another law, for example because it would contravene a law of the Commonwealth or the State (s.49(3A)) or would give rise to an unacceptable risk of serious or material environmental harm; or where the chief executive is required to refuse to allow the EIS to proceed under a regulatory requirement.. If the decision is to allow the EIS to proceed, the chief executive may also fix a minimum period for the making of submissions about the EIS. However the fixed period must be at least 30 business days and must end at least 30 business days after the EIS notice is published. Subject to the requirements of s. 49A, an EIS can be resubmitted within 3 months of a decision, or different period agreed to, where it has initially been refused, or has been allowed to proceed on conditions.. It must be accompanied by the relevant fee (see Schedule 15, Part 1 of the EP Reg). There is a fee for submitting an EIS, but no fee has been set for resubmitting an EIS.

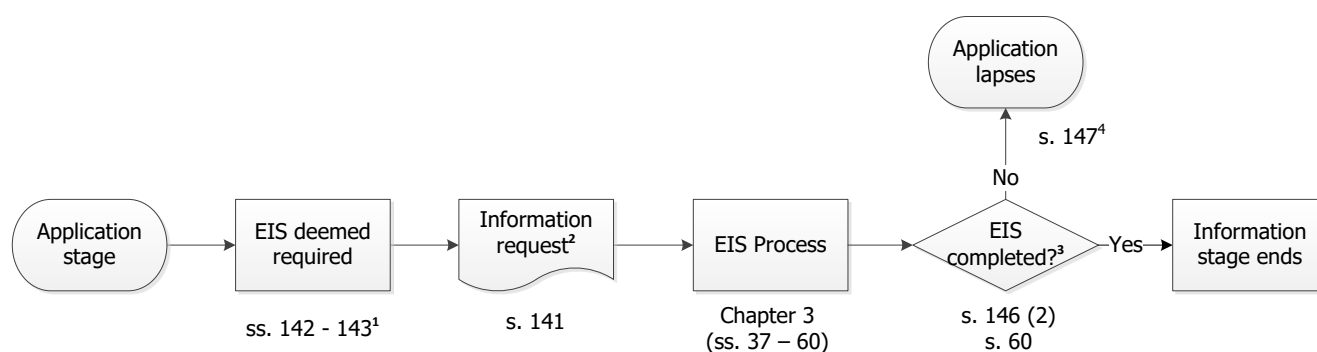

**Figure 7: Information stage where an EIS is required**

**Notes:**

**<sup>1</sup> EIS**

An EIS may be required for a site specific application for a resource activity if the project does not relate to a coordinated project, the chief executive has granted an approval for the applicant to voluntarily prepare an EIS under chapter 3, part 2 and the EIS process has not yet been completed under chapter 3, part 1; or, an EIS process for an EIS for the application has otherwise not been completed under chapter 3, part 1; or, an EIS assessment report relating to the application has lapsed under section 59A.

**<sup>2</sup> Assessment timeframes**

An information request must be made within:

- 30 business days for a site-specific application accompanied by a proposed PRC plan
- 20 business days for a site-specific application
- 10 business days for a variation application (s. 144).

The period may be extended by the administering authority through written notice.

The response period must be stated in the information request.

The period must be at least two years after the final Terms of Reference are given to the proponent under s. 46 (1).

**<sup>3</sup> Completing the EIS**

The information stage will end when the EIS process is completed under s. 60. This is when the EIS assessment report is given to the applicant by the administering authority.

**<sup>4</sup> Application lapsing**

If the EIS process is not completed within the stated period the application will lapse. The applicant may request to extend the response period (s. 147).

**2.8.2 The notification stage where an EIS is required**

Where an EIS is required to be completed within the information stage, the public notification conducted for the EIS is taken to be the public notification required under Part 4 (the notification stage). The applicant will not need to undergo public notification again for the EA application. Any submissions made for the EIS will be taken to be properly made submissions for the EA application. Under s. 56A, the 20 business day decision-making period on whether to allow the EIS to proceed in response to submissions can be extended with the applicant's written agreement any time before the decision. The submitted EIS can only be allowed to proceed if the proponent's response to any submissions is adequate and the proponent has made all appropriate amendments to the submitted EIS because of the submissions. A written notice is issued within 10 business days of the decision. Under s. 56AA, if refused, the applicant has 20 business days or other agreed period to resubmit the EIS with their response to submissions and must be accompanied by relevant fees.

The decision to allow the EIS public notification to satisfy Part 4 public notice requirements is outlined in an information notice issued to the applicant at the same time as the information request requiring the EIS.

An information notice gives details of the decision, the reasons for the decision and the review or appeal details.

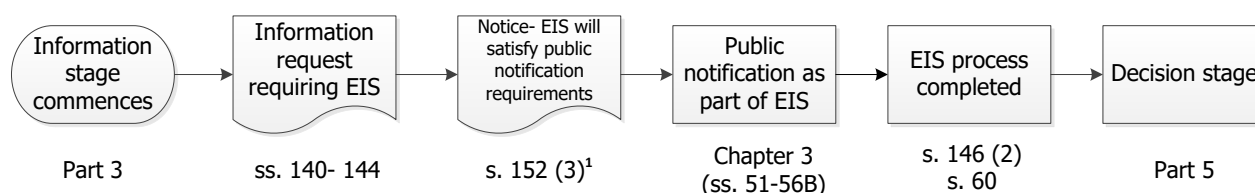

Figure 8: Public notification where an EIS is required

**Notes:**

**¹ Substituted way to publish application notice**

The administering authority issues a notice of decision that the public notification of the EIS will satisfy the public notification requirements of the application for an EA (s. 152 (3)).

### 3. Registration of a suitable operator

An application for registration as a suitable operator can be made with, or prior to, a new EA. All applications for registration as a suitable operator are assessed by DESI as the chief executive of the EP Act. If made together with a new EA application, which is to be assessed by another administering authority other than DESI, that administering authority forwards the application for registration as a suitable operator to DESI for assessment.

Once an application for registration is received a suitability report may be sought for the applicant prior to assessment. A decision is then made to either approve or refuse the application. The grounds for refusal are outlined in s. 318H and include matters such as the applicant’s environmental record or any disqualifying event which may have occurred for the particular individual or corporation applying.

Where the application is approved a written notice of approval is issued to the applicant and the applicant’s details are added to the suitable operator register (available at [www.des.qld.gov.au](http://www.des.qld.gov.au)). Where the application was made alongside an EA application with another administering authority, a copy of the decision notice is also given to the relevant administering authority. Figure 9 outlines the application process to be a registered suitable operator.

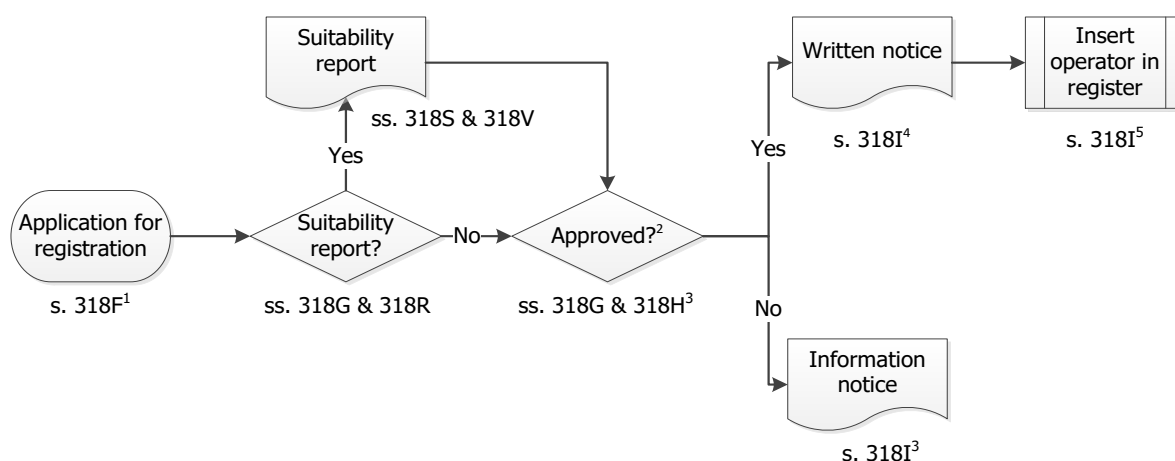

Figure 9: Registered suitable operator application process

**Notes:**

¹ An application for a suitable operator registration must be in the approved form.



## **<sup>2</sup> Decision**

Where a suitability report is obtained under s.318R, the decision must be made within 20 business days after receiving the application. Where no suitability report is obtained under s.318R, the decision must be made within 10 business days after receiving the application.

## **<sup>3</sup> Grounds for refusing application**

The chief executive may refuse the application if:

- \* the applicant is not suitable due to their environmental record
- \* a disqualifying event has happened to:
  - o the applicant
  - o a partner of the applicant
  - o any of the corporation's executive officers
  - o another corporation where any of the applicant's corporation are, or have been executive officers.

## **<sup>4</sup> Notice is also sent to administering authority**

If the application for a suitable operator registration was received by an administering authority (other than the chief executive, for example a local government) in conjunction with the application for an EA, then the chief executive must also give the administering authority notice of the decision.

## **<sup>5</sup> Date registration takes effect**

A registered suitable operator's registration has effect from the day the operator's name and address are included in the suitable operator register and continues in force for 5 years after an operator is not the holder of an EA.

# **4. When an EA takes effect**

An EA cannot take effect before:

- a resource tenure is granted (for resource activities)
- a development permit for a material change of use takes effect (for prescribed ERAs).  
This applies where the assessable development trigger is a material change of use for an ERA or if the proposed development triggers assessable development as a material change of use for other triggers under the *Planning Act 2016*.
- a State Development Area approval takes effect under the *State Development and Public Works Organisation Act 1971*.

If the authority is for a prescribed ERA the take effect day can be nominated by the holder of the authority as part of the application process or by written notice to the administering authority.

If none of the above apply the EA takes effect on a day or event stated by the administering authority on the EA or if no date is stated, on the day the EA is issued.

It is an offence to carry out an EA for an ERA if the EA has not taken effect. Incorrectly claiming that a development permit has been issued or is not required may result in prosecution for operating without an EA and for providing false or misleading information.

# **5. Amendment of an EA (by application)**

An EA amendment application may be:

- a minor amendment (condition conversion) to convert all your EA conditions to standard conditions provided you can meet all the eligibility criteria;
- any other minor amendment—known as a minor amendment (threshold); or
- a major amendment, which is an amendment that is not a minor amendment.

Amendment applications must be able to be made in accordance with ss. 224–225 and meet the application requirements in part 7, division 2. An example of an EA amendment application which would not be able to be made is where the proposed change requires a development permit under the Planning Act and a development application has not been made, or where the proposed change is to add an ERA that would result in the EA applying to activities that were not being carried out as an ERA project. An amendment application is considered a properly made amendment application if it complies with part 7, division 2.

## 5.1 Assessment level decision

The administering authority will decide whether an amendment application is a minor amendment (threshold) or a major amendment. This decision is known as the assessment level decision (ALD).

An ALD is not required for a condition conversion (see section [5.3](#)).

An application to amend a condition requiring compliance with the relevant eligibility criteria can be refused without an ALD (see section [5.5](#)).

Where required, the ALD is made by the administering authority within 10 business days after receiving the amendment application. The applicant is given notice of the decision within 10 business days of ALD.

## 5.2 Minor amendment (threshold)

A minor amendment (threshold) is one that meets the definition under s. 223. Applications for a minor amendment (threshold) must be decided within 10 business days after the ALD notice is given. If approved the amended EA is issued to the applicant within five business days after the application decision is made. If refused a notice of refusal is issued within five business days after the decision is made.

**Minor amendment (threshold)** means an amendment that:

- \* is not a change to a condition identified in the EA as a standard condition, other than:
  - o a change that is a condition conversion, or
  - o a change that is not a condition conversion but that replaces a standard condition of the EA with a standard condition for the ERA to which the EA relates
  - o A change that will not result in a change to the impact of the relevant activity on an environmental value; and
- \* does not significantly increase the level of environmental harm caused by the activity
- \* does not change any rehabilitation objectives in a way likely to result in significantly different impacts on environmental values than the impacts previously permitted
- \* does not significantly increase the scale or intensity of the activity
- \* does not relate to a new relevant resource tenure
- \* involves an addition to the surface area for the relevant activity of no more than 10% of the existing area
- \* for an EA for a petroleum activity:
  - o if the amendment involves constructing a new pipeline—the new pipeline does not exceed 150 kilometres
  - o if the amendment involves extending an existing pipeline—the extension does not exceed 10% of the existing length of the pipeline
- if the amendment relates to a new exploration permit or greenhouse gas permit—the amendment seeks an amended EA that is subject to the standard conditions for the relevant activity or authority, to the extent it relates to the permit (s. 223).

For further information refer to the guideline 'Major and minor amendments') available at [www.qld.gov.au](http://www.qld.gov.au) using search term 'ESR/2015/1684'.

### 5.3 Minor amendment (condition conversion)

A minor amendment (condition conversion) must be decided within 10 business after receiving the amendment application. There is no ALD for condition conversion applications.

### 5.4 Major amendment

All amendments that are not a minor amendment (condition conversion or threshold) are a major amendment. For further information refer to the guideline ‘Major and minor amendments’ available at [www.qld.gov.au](http://www.qld.gov.au) using search term ‘ESR/2015/1684’.

For a major amendment Parts 3 (information stage), 4 (notification stage) and 5 (decision stage) apply to the application as if it were a new site-specific EA application. For instance if the amendment is for an EA related to a prescribed ERA, the information and decision stages would apply. Whereas if the amendment is for an EA to add a new mining lease the information, notification and decision stages would apply.

Figure 10 below outlines the main steps of the EA amendment application process.

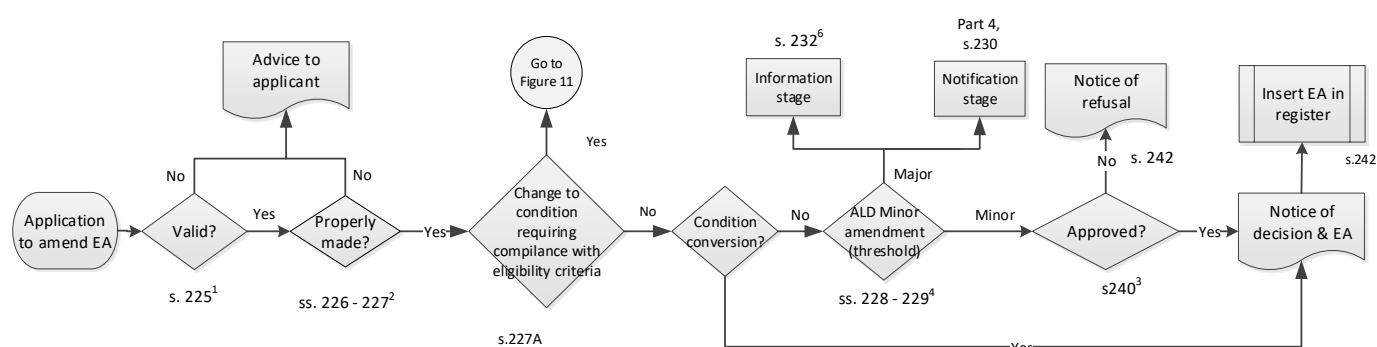

Figure 10: EA amendment application process

#### Notes

##### <sup>1</sup> Valid application

An amendment application for an EA for a prescribed ERA cannot be made if:

- \* the proposed amendment involves changes to the relevant activity and under the Planning Act a development permit for a material change of use is necessary for the carrying out of the changed activity; and
- \* the development application for the development permit has not been made.

An amendment application for an EA can not be made if:

- the proposed amendment is to add and ERA; and
- if the amendment application were approved, the addition of the activity would result in the EA applying to activities that were not being carried out as an ERA project.

#### Amendments relating to an EA and a PRCP schedule

If the holder of an EA and a PRCP schedule makes an amendment application and the application is to amend only one of the relevant environmental requirements, the EA holder must apply to amend the other relevant environmental requirement if approval of the amendment would make the requirements inconsistent. This is to ensure there are no inconsistencies between the environmental requirements.

##### <sup>2</sup> Properly made amendment application

An amendment application under section 224 is a properly made amendment application if it complies with part 7, division 2 (s. 227AAA).

If an amendment application is a not properly made amendment application the administering authority must issue a not properly made amendment application notice within 10 business days of receiving the application. This notice will state that the amendment application is not properly made, the reasons the administering authority is satisfied it is not properly made, the action the applicant must take to make the application properly made, and the period, or at least 20 business days, within which the applicant must give written notice the administering authority that the action has been taken (s. 227AAB).

If the applicant does not give written notice to the administering authority within the stated period the amendment application will lapse (s. 227AAC)

### **<sup>3</sup> Deciding amendment application**

If the application is for a condition conversion, the administering authority must decide either to approve or refuse an application within 10 business days after the application is received.

For other amendment applications, the administering authority must decide to approve or refuse an application within 10 business days after notice of the assessment level decision is given to the applicant or, if the applicant agrees to extend the period by no more than 20 business days, within the extended period.

### **<sup>4</sup> Assessment level decision**

An ALD must be made by the administering authority to decide if the proposed amendment is a major or minor amendment (threshold) (s. 228). An ALD must be made within 10 business days after receiving the application or, if the administering authority gives the applicant a not properly made amendment application notice, within 10 business days after the applicant gives the administering authority the notice that the action has been taken (s. 228(1)). The administering authority must send a notice of ALD to the applicant (s. 229) within 10 business days after making the ALD.

### **<sup>5</sup> Process for major amendments**

For major amendments the information stage, notification stage and decision stages are applied in the same way as if the amendment application were a site-specific EA application.

## **5.5 Amendment of condition requiring compliance with eligibility criteria**

Where an EA amendment application seeks to amend the condition under section 204 requiring compliance with the eligibility criteria (s 227A)<sup>3</sup>, the administering authority may:

- refuse the application without an ALD
- refuse the application without an ALD and require the applicant to make a site-specific application for an EA; or
- undertake an ALD and allow the application to proceed as a major amendment.

The administering authority may refuse this type of application within 10 business days of receipt of application.

When refusing this type of application, the administering authority can require the applicant to make a site-specific application for a new EA to replace the existing EA.

It may be appropriate for the administering authority to simply refuse the application where the EA holder can meet the eligibility criteria.

It may be appropriate for the administering authority to refuse the EA amendment application and require a site-specific application where the EA holder cannot meet the eligibility criteria for the activity which is the subject of

---

<sup>3</sup> This is a standard condition.

the EA amendment application. This is consistent with the requirement for a site specific application where the eligibility criteria cannot be met for a new EA application.

If proposing to require a site-specific application, the administering authority must give written notice of the proposed requirement to the holder of the EA and give the holder at least 20 business days to make written representations to show why the requirement should not be made. The administering authority must consider any representations made by the holder within the allowed period and give the holder written notice of the decision. If the decision is to require a site-specific EA application, the holder must comply with this requirement.

The EA amendment application can be allowed to proceed as a major amendment<sup>4</sup> if the non-compliance with the eligibility criteria is beyond the control of the EA holder. If the EA amendment application is allowed to proceed, an ALD is required to confirm that the application is a major amendment.

#### Example of when an EA amendment application can proceed as a major amendment

An activity meets the eligibility criterion requiring the activity to be at least 500 metres from a sensitive receptor (such as a residence) until a residential development is constructed within 500 metres of the activity. The amendment application in this case proceeds to the ALD and is assessed as a major amendment.

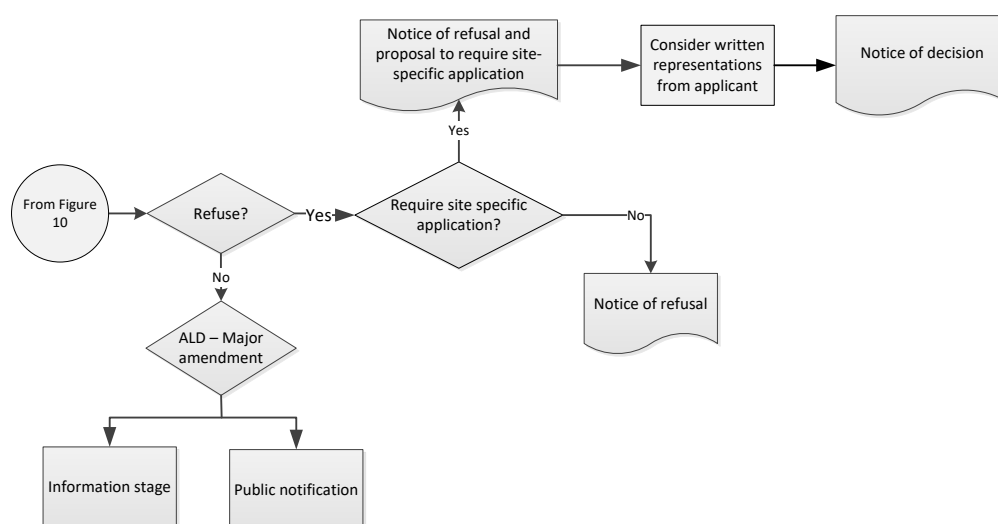

**Figure 11: Process where applicant seeking to amend condition requiring compliance with the eligibility criteria**

## 5.6 Public notification for a major EA amendment related to a resource activity

Where the proposed EA amendment is assessed to be major and related to a resource activity, the administering authority, the public notification requirements in Chapter 5, Part 4 of the EP Act will apply. The administering authority must notify the applicant that public notification is required in the ALD notice. The notification stage commences as if the application were a site-specific application. Please see section 2.5 for further information, noting that a decision to fix the submission period under s. 234 may not occur until after the applicant has paid the required assessment fee prescribed by regulation (see s. 232(3A)).

## 6. Amalgamation of EAs

<sup>4</sup> As the application involves a change to a standard condition, the ALD would be that the application is a major amendment.

The holder of two or more EAs can amalgamate them into one EA provided certain requirements are met. An amalgamation application can only be made if the holder for all the EAs is the same person and all EAs are administered by the same administering authority. There are three different types of amalgamation applications under the EP Act; local government, project and corporate authorities. For each type, the requirements under s. 246 must be met.

For an amalgamated project authority or an amalgamated local government authority application to be approved, all the activities must be conducted as a single integrated operation. A single integrated operation is one where:

- the activities are carried out under the day-to-day management of a single responsible individual, for example, a site or operations manager
- the activities are operationally interrelated
- the activities are, or will be, carried out at one or more places, and
- the places where the activities are carried out are separated by distances short enough to make feasible the integrated day-to-day management of the activities.

Amalgamated corporate authority applications do not have this requirement and are automatically approved if the s. 246 requirements are met. For amalgamated corporate authorities the annual fee is the sum of the annual fees for **each** site (the highest annual fee for each site). For amalgamated local or project authorities the highest of annual fee for ERAs across all the sites is required to be paid (one highest annual fee is paid overall). Figure 12 outlines the EA amalgamation application process.

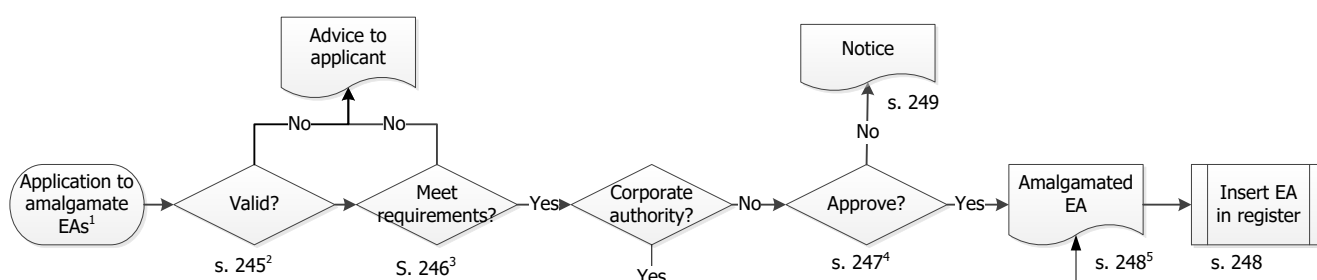

**Figure 12: EA amalgamation application process**

### **Notes:**

#### **<sup>1</sup> Types of amalgamated environmental authorities**

The types of amalgamated environmental authorities are:

- \* amalgamated corporate authorities
- \* amalgamated local government authorities
- \* amalgamated project authorities.

#### **<sup>2</sup> Valid application**

A holder of multiple EAs may apply to amalgamate only if all EAs have the same holder/s and administering authority. For amalgamation applications related to resource activities, the holder of an EA for a resource activity is the holder of the relevant tenure, therefore to amalgamate an EA all EA holders must also be the holders of the relevant resource tenures.

#### **<sup>3</sup> Application requirements**

The application is accepted and able to progress where the following requirements are met. The application must:

- \* be in the approved form
- \* state the type of amalgamated authority being applied for

## Approval processes for environmental authorities

---

- \* include enough information to allow the administering authority to make a decision
- \* if PRC plans relating to the environmentally relevant activities for the environmental authorities will require amalgamation if the application is approved, be accompanied by a proposed amalgamated PRC plan for the activities
- \* if the application is for an amalgamated corporate authority—be accompanied by an application under section 316L to change the anniversary day for each of the existing EAs to a new day that is the same for all of the authorities
- \* if the application is for an amalgamated local government authority or amalgamated project authority and the highest annual fee is the same for 2 or more of the existing EAs—nominate the anniversary day for 1 of the authorities with the highest annual fee as the anniversary day for the amalgamated EA
- \* be accompanied by a fee prescribed by regulation (s. 246).

#### **4 Decisions for different types of amalgamations**

For amalgamated local government authority applications, the administering authority must only approve the application if:

- \* the applicant is a local government
- \* the relevant activities in the existing authorities do not constitute a significant business activity
- \* there is an appropriate degree of integration between the activities.

For amalgamated project authority applications, the administering authority must only approve the application if it is satisfied the relevant activities are being carried out as a single integrated operation (s. 113 of the EP Act).

If the administering authority approves an application for an amalgamated project authority for environmental authorities for which a PRCP schedule also applies, each of the schedules must be also be amalgamated.

Amalgamated corporate authorities are given an automatic approval.

A decision for all types of amalgamation applications must be made within 20 business days after the application is received.

#### **5 Steps after deciding**

The administering authority must amalgamate the existing EAs within five business days after approving an application or issue a notice of refusal within 10 business days after deciding the application.

If the decision is to approve an amalgamation application, and PRCP schedules for existing environmental authorities are amalgamated, the administering authority must give the applicant a copy of the amalgamated PRCP schedule.

If the administering authority decides to approve an amalgamation for an amalgamated local government authority or amalgamated project authority, the anniversary day for the amalgamated EA is:

- \* if the highest annual fee is the same for 2 or more of the existing EAs immediately before the approval of the amalgamation application—the anniversary day nominated by the applicant under section 246(f); or
- \* otherwise—the anniversary day for the existing EA that had the highest annual fee immediately before the approval of the amalgamation application (s. 247A).

If an amendment application is made, but not decided, before an amalgamation application, and the amalgamation application is approved, the amendment application is taken to be an application to amend the amalgamated EA (s. 250).

## **7. De-amalgamate an EA**

There is a simple process for de-amalgamation of an EA. This applies where a single EA covers multiple activities, such as where one ERA project EA is approved for a single integrated operation or where multiple environmental authorities are amalgamated post-approval. In either of these cases, the single EA may cover multiple activities and may include multiple resource tenures.

An EA can be de-amalgamated if:

- it is not a resource project; or
- it is a resource project EA and:
  - the project is no longer being carried out as a single integrated operation
  - it is proposed that the project will no longer be carried out as a single integrated operation, or
  - the existing holder is proposing to transfer the related resource tenure to another person (a transfer tenure).

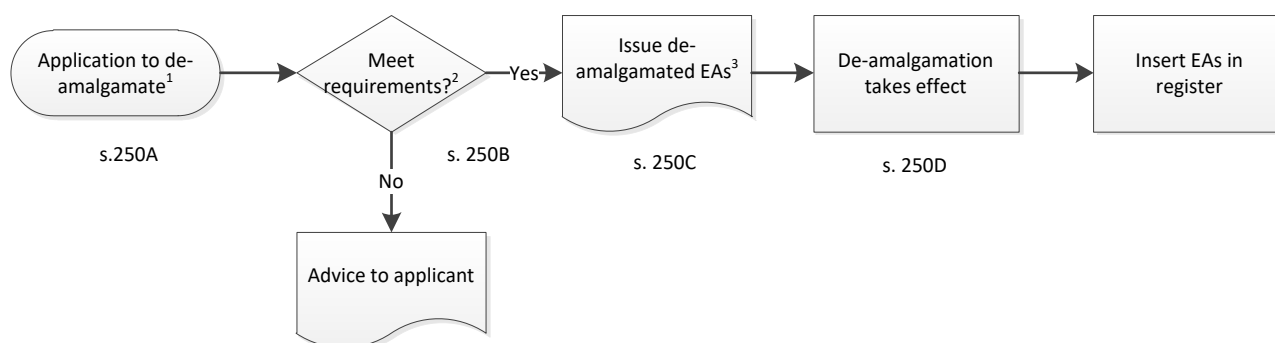

**Figure 13: EA de-amalgamation application process**

### **Notes:**

#### **<sup>1</sup> Application requirements**

The application must:

- be made in the approved form
- if the application relates to a resource project be accompanied by a declaration by the applicant that:
  - the project is no longer being carried out as a single integrated operation, or
  - the existing holder is proposing to no longer carry out the project as a single integrated operation, or
  - the existing holder is proposing to transfer to another person a resource tenure to which the EA relates, and
- if a PRCP schedule relating to environmentally relevant activities for the authority will require de-amalgamation if the application is approved, be accompanied by proposed de-amalgamated PRC plans for the activities
- if an ERC decision is, or has been, in effect for the EA—be accompanied by an application under section 298 for an ERC decision for each of the proposed de-amalgamated EAs.
- be accompanied by the fee prescribed by regulation,

#### **<sup>2</sup> Steps after receiving de-amalgamation application**

Within 15 business days or within the agreed extended period after receiving a de-amalgamation application that complies with s. 250B, the administering authority must:

- \* de-amalgamate the relevant authority to give effect to the de-amalgamation
- \* for de-amalgamation of an environmental authority for relevant activities to which a PRCP schedule relates, de-amalgamate the schedule to the extent necessary to give effect to the de-amalgamation of the authority
- \* issue two or more EAs to the applicant
- \* give the applicant a copy of any de-amalgamated PRCP schedules
- \* include a copy of each EA issued and each de-amalgamated PRC plan in the relevant register.

If an ERC decision is, or has been, in effect for the EA, the administering authority may only do the things mentioned above after the administering authority makes an ERC decision for each of the proposed de-amalgamated EAs.



## Approval processes for environmental authorities

The administering authority may make amendments to each de-amalgamated EA to the extent necessary for the de-amalgamation, and only if the applicant agrees in writing to the variation (s. 250C).

A de-amalgamation application that does not comply with s. 250B will be refused.

### <sup>3</sup> When de-amalgamation takes effect

The de-amalgamation of an EA takes effect:

- \* if it relates to a transfer tenure, when the transfer tenure is transferred and the proposed holder of each de-amalgamated EA has paid a contribution to the scheme fund or given a surety for the authority under the *Mineral and Energy Resources (Financial Provisioning) Act 2018*
- \* if it relates to a relevant authority for a resource project for which the existing holder proposes to no longer carry out the project as a single integrated operation, when the existing holder stops carrying out the project as a single integrated operation
- \* otherwise, when the administering authority issues 2 or more environmental authorities to the applicant under s. 250C(b).

## 8. Transfer of an EA for prescribed ERAs

The holder of an EA for a prescribed ERA can apply for a full transfer of their EA to another person by lodging an EA transfer application with the relevant administering authority. For example, where a business that involves carrying out an ERA is sold, the new owner will need to hold the EA for the activity. This includes a partial transfer, where the applicant wishes to transfer some, but not all, ERAs to a new holder. For example, where part of a business that involves carrying out some ERAs is sold, the new owner will need to hold the EA for the ERAs for the part of the business that was sold, while the original operator will need to have an EA for the ERAs for the part of the business that was not sold.

There is one exception where a transfer is unable to be made and that is for an EA that was issued based on trial technologies for a prescribed activity.

A transfer application must meet the requirements under s. 253. If the requirements are met, and the new holder is a registered suitable operator the transfer application must be approved. Figure 14: below outlines the EA transfer application process for prescribed ERAs.

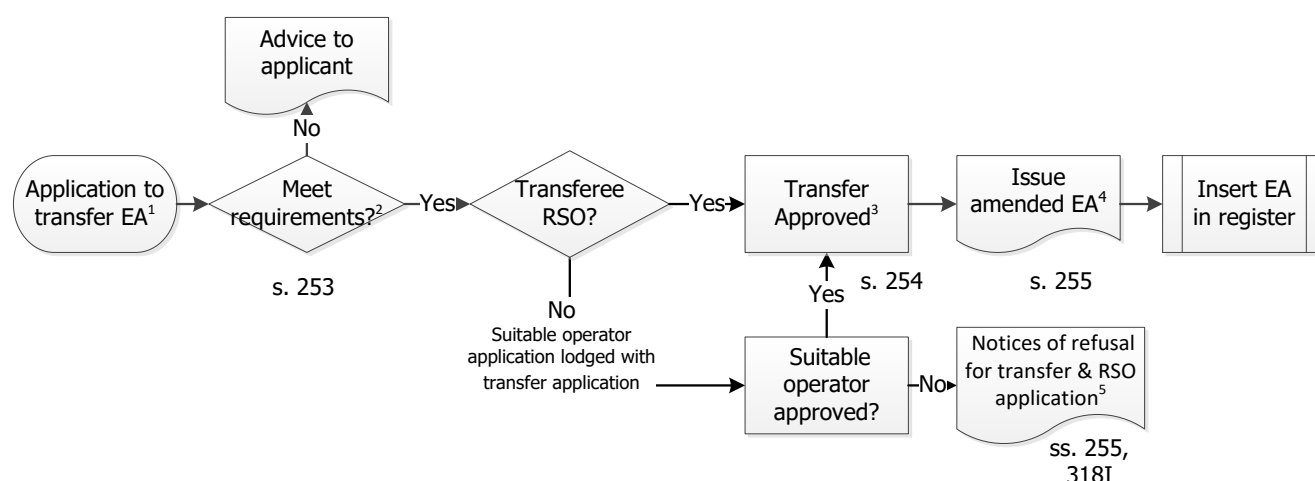

Figure 14: EA transfer application process for prescribed ERAs

### Notes:

#### <sup>1</sup> Applicant and activity types

The existing holder of the EA for a prescribed ERA may apply to transfer all or part of the EA to another person.

## <sup>2</sup> Application requirements

The application must:

- \* be in the approved form
- \* include details of the proposed holder
- \* be signed by both the existing and proposed holders
- \* state whether the proposed holder is a registered suitable operator (RSO)
- \* if the proposed holder is not a RSO, the application must be accompanied by an application for a registration as a suitable operator
- \* be accompanied by the fee prescribed by regulation.

## <sup>3</sup> Deciding transfer application

The administering authority must approve the application if the proposed holder is a suitable holder. The transfer application can only be refused if the RSO application under Chapter 5A, Part 4, Division 1 is refused. (ss. 318H and 318I)

## <sup>4</sup> Steps after approving the application

The administering authority must amend and issue the relevant EA to give effect to the transfer. If the transfer is partial, an EA is issued to both the new and existing holder.

If the new operator is not the owner of the land for the EA, they must notify the owner of the land of the change.

## <sup>5</sup> Steps after refusing the application

If the RSO and transfer applications are refused, a written notice of refusal for each application is issued.

If the administering authority refuses the transfer application, it must send a written notice of the decision to the existing holder **and** to the proposed holder.

## 9. How an EA for a resource activity is transferred

An EA for a resource activity is not transferred by application under the EP Act. The EA attaches to the tenure through the definition of 'holder' in Schedule 4 of the EP Act:

- the holder of an EA for a resource activity is the holder of the relevant tenure
- the holder of a resource tenure is the holder of tenure under resource legislation.

Consequently, when the tenure is transferred under the relevant resource legislation, the EA automatically travels with the tenure; no application to transfer an EA is required. As the transfer of resource tenure is administered by DOR, DESI receives notification from DOR when tenure is transferred in order to carry out the corresponding transfer of the EA. The new holder of the resource tenure must be a registered suitable operator (see [section 2](#)).

Figure 15 below outlines transfer process for an EA for a resource activity.

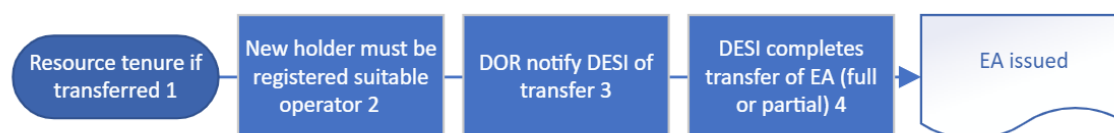

Figure 15: EA transfer process for resource activities

### Notes:

#### <sup>1</sup> Resource tenure transfer

## Approval processes for environmental authorities

Environmental authorities for resource activities are not transferred by application as they attach to the tenure through the definition of ‘holder’ in Schedule 4 of the EP Act.

### <sup>2</sup> New holder must be registered suitable operator

The new operator will need to apply to be a registered suitable operator before commencing the activity if not already registered.

### <sup>3</sup> DOR notify of transfer

DOR notify DESI on a regular basis of all tenures that have been transferred to new holders.

### <sup>4</sup> DESI completes transfer of EA

Once notification of the transfer of tenure is received from DOR, DESI checks the relevant EA and determines if the transfer of tenure results in a full or partial transfer of the EA. Where all tenures on the EA are being transferred to a new holder, the EA transfer is a full transfer. DESI will also check that the new holder is a registered suitable operator.

## 10. Surrender of an EA

An application to surrender an EA can either be applicant driven, or required by the administering authority. Under both scenarios, an application to surrender an EA must meet the requirements of ss. 257 and 262 to be accepted and able to progress. The administering authority decides if further information is required to make a decision on the application. If further information is required, an information request notice must be issued within 20 business days of receiving the application.

In some circumstances a final rehabilitation report, or post-surrender management report, and compliance statement must also be provided as part of the surrender application. If a decision is made to approve the surrender application, there is the ability for the administering authority to require the applicant to make a residual risk payment before the surrender takes effect. Further, if the surrender application is refused the administering authority may make a rehabilitation direction. Figure 16: outlines the process required to surrender an EA.

Please note that for an EA related to a resource activity either a full and partial surrender can be applied for through a surrender application. Only a full surrender is possible for a prescribed ERA. For removing conditions for a prescribed ERA that is no longer performed from an EA that permits the operation of several ERAs, an EA amendment application is required rather than a surrender application.

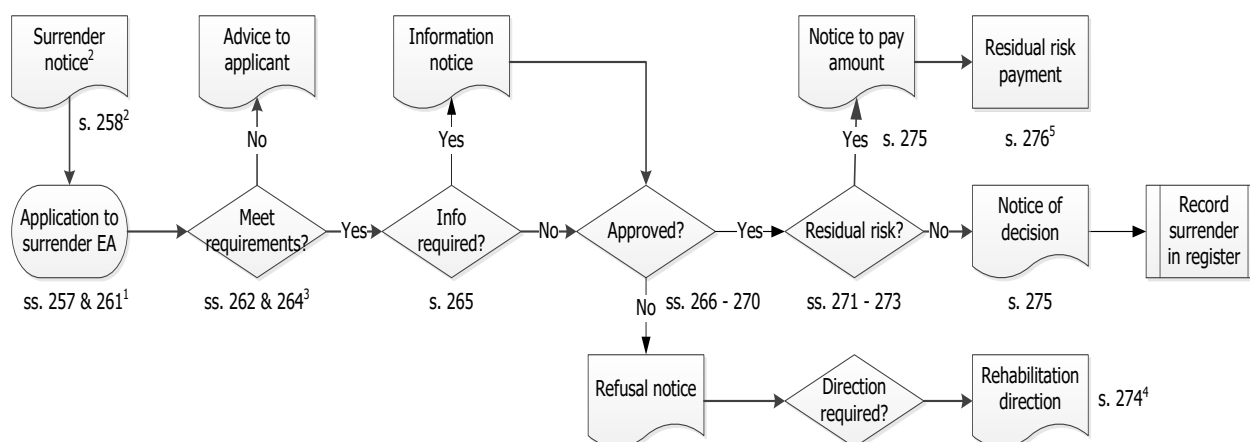

Figure 16: EA surrender application process

### Notes:

**<sup>1</sup> Applicant and partial surrender applications**

The holder of the EA may apply to surrender their EA (s. 257). For resource activities, a surrender application may only be made if a surrender application for the relevant tenure is also made. For tenures that have been cancelled, in whole or in part, under the relevant resource legislation, an invitation to make a surrender application will be sent to the EA holder by the administering authority (s.258). This is because an EA must be held for the same area as the tenure.

The administering authority may approve a surrender application for part of an EA for a mining, petroleum or geothermal activity (s. 261).

**<sup>2</sup> Surrender notices**

The administering authority may give the holder of an EA for a mining, petroleum or geothermal activity a surrender notice requiring the holder to make a surrender application if:

- \* a relevant tenure for the EA is cancelled
- \* a relevant tenure for the EA is to end other than by cancellation
- \* the EA is for a petroleum activity, the area of a relevant tenure for the EA is reduced under a requirement of non-compliance action taken under the resource legislation
- \* part of the area of a relevant tenure for the EA is relinquished, other than under a requirement of non-compliance action taken under the resource legislation
- \* part of the area of a relevant tenure for the EA is surrendered.

The surrender notice must give the holder at least 30 business days to make the surrender application and include an information notice about the decision to require the surrender application. An information notice gives details of the decision, the reasons for the decision and the review or appeal details.

**<sup>3</sup> Application requirements**

The application is accepted and able to progress if it meets the requirements as stated in s. 262 and is accompanied by the fee prescribed by regulation.

For EAs which contain rehabilitation conditions and no PRCP schedule applies for the relevant activities, a final rehabilitation report is required and must include enough information to allow the administering authority to decide whether:

- the conditions of the EA have been complied with
- the land has been satisfactorily rehabilitated.

For an EA other than for a resource activity, it also must describe the on-going environmental management needs for the land. For an EA for a resource activity, it also must meet the requirements under s. 264(1)(d).

The application must also be accompanied by a compliance statement which states whether the EA conditions have been complied with and the extent to which the final rehabilitation report is accurate.

If a PRCP schedule applies for the relevant activities, a post-surrender management report that meet the requirements under s. 264A must be submitted as part of the application

The accompanying compliance statement when a PRCP schedule applies for the relevant activities must include enough information to allow the administering authority to decide whether:

- the rehabilitation milestones and management milestones under the schedule have been met
- the extent to which conditions imposed on the schedule have been complied with
- the extent to which the post-surrender management report is accurate and complies with s. 264A.

**<sup>4</sup> Rehabilitation direction**

Where an EA surrender application is refused the administering authority may give the EA holder written direction to carry out further rehabilitation within a stated period. This written direction is called a rehabilitation direction and once given the EA holder must carry out the rehabilitation actions as specified. If the holder then wishes to surrender the EA they must reapply by making another application to surrender the EA.

Please note, where a resource tenure is automatically relinquished, the holder may no longer have access to the land to carry out a rehabilitation direction. Where this is the case, the permission to access land must be obtained either by an agreement with DOR, or by an entry order under s. 575.

#### <sup>5</sup> When surrender takes effect

The surrender will only take effect once the residual risk payment requirements have been complied with.

## 11. Suspension of an EA (by application)

An EA holder may at any time apply to suspend or extend the suspension of their EA. A suspension application must meet the requirements of s. 284B. The application must identify whether the suspension is for one, two or three years in duration from the next anniversary date for the EA

The suspension of an environmental authority limits the provisions that can apply to a suspended authority, however, s. 278B of the EP Act continues the application of certain provisions. This includes environmental evaluation and offence provisions, where conditions and compliance tools can be enforced on suspended authorities.

When approved, no annual fees are payable throughout the suspended period and the holder is not authorised to carry out the ERA.

Figure 17 outlines the application process for suspending an EA.

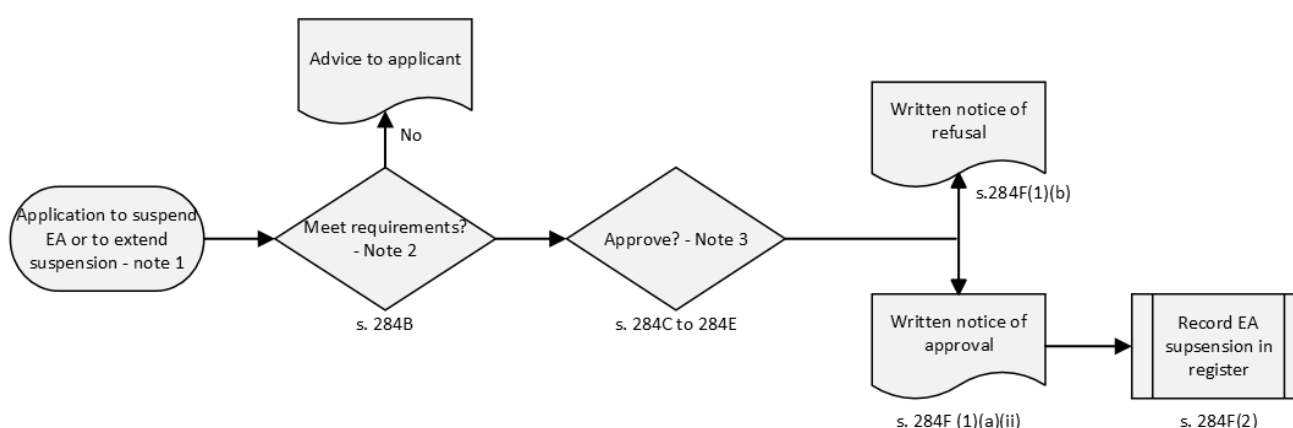

Figure 17: EA suspension application process

#### Notes:

<sup>1</sup> The holder of an EA may at any time apply to suspend or extend the suspension of the EA

#### <sup>2</sup> Application requirements

The application is accepted and able to progress if the following requirements are met. The application:

- \* is made to the administering authority
- \* is in the approved form
- \* is accompanied by the fee prescribed by regulation
- \* nominates the period of suspension, which must be for 1, 2 or 3 years from either the next anniversary day for the EA or from the end of the existing suspension period.

#### <sup>3</sup> Deciding the application

The administering authority must make a decision within 20 business days of receiving the application.

## 12. Amendment of an EA (by the administering authority)

The administering authority can initiate a process to amend an EA where the amendment is considered necessary and desirable or the EA holder has agreed in writing to the amendment. Where the holder has not agreed in writing to the amendment, the circumstances where the administering authority can propose an EA amendment are stipulated under s. 215. Some examples are:

- where an EA has been issued for a standard or variation application but the relevant activity does not comply with the eligibility criteria for the activity
- the EA was issued because of a materially false or misleading representation or declaration, made either orally or in writing
- there is a significant change in the way, or extent to which, the activity is being carried out.

Another basis for an amendment is s. 701 where the EA:

- has a condition requiring compliance with an environmental management plan or
- an environmental management plan states environmental protection commitments for rehabilitation of the land to be disturbed under each relevant resource tenement.

The administering authority may amend the EA in these circumstances to impose conditions consistent with the environmental management plan within two years of the EA commencing or taking effect.

Where the administering authority proposes to amend an EA, the holder of the EA must be sent details of the proposed amendment and given an opportunity to make written representations about the proposed change. After considering any written representation the administering authority may make the amendment if it still believes a ground exists to make the amendment. The holder must be advised of the decision—whether to make the amendment or not.

The administering authority can make an amendment at any time to correct a clerical or formal error (s. 211), provided the amendment does not adversely affect the interests of the holder of the EA or anyone else; and the holder has been given written notice of the amendment. The administering authority can also amend under ss. 212 to 214 by giving the holder written notice of the amendment. Figure 18 outlines the process for EA amendments initiated by the administering authority.

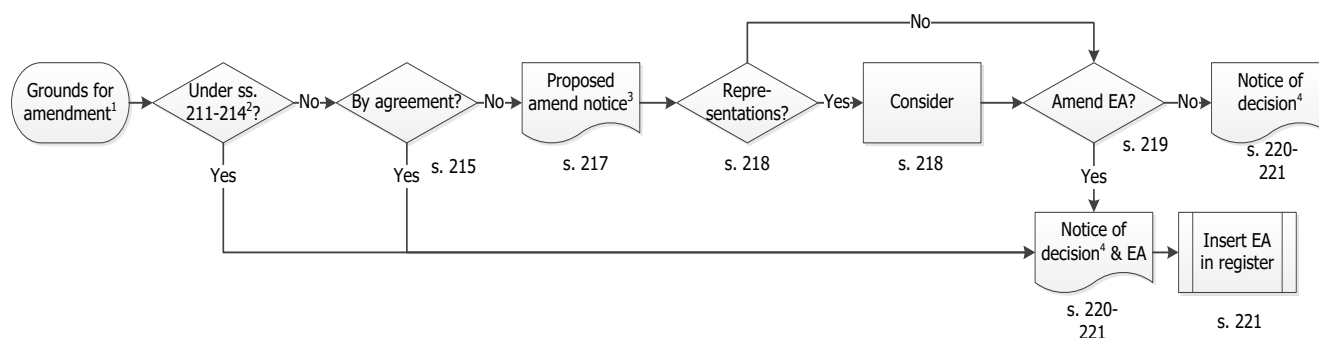

Figure 18: EA amendment process by the administering authority

**Notes:**

**¹ Grounds for amending EA**

Grounds must exist for the administering authority to initiate the amendment process under Part 6. Sections 211 to 215 outline what these are.

**² Amendment triggers**

The administering authority may amend an EA to:

- \* reflect corrections to clerical or formal errors (s. 211)
- \* ensure compliance with National Native Title Tribunal conditions (s. 212)
- \* ensure consistency with a regional interests development approval, where the EA is for a resource activity or a regulated activity under the *Regional Planning Instruments Act 2014* (s. 212A)
- \* reflect new standard conditions, where the new ERA Standard containing the states that the standard conditions would apply to existing EAs (s. 213)
- \* follow directions from the Planning Minister (s. 214).
- \* impose conditions consistent with an environmental management plan (s. 701).

### **<sup>3</sup> Proposed amendment notice**

The administering authority must give the holder of the EA a proposed amendment notice. This applies to amendments triggered under s. 215(2). The notice must include:

- \* the proposed amendments
- \* the grounds for the proposed amendment
- \* that the operator may make written representations within a stated period to show why the amendments should not be made (s. 217).

The amendment notice must also be accompanied by a copy of the EA showing the changes.

The timeframe stated for the EA holder to make representations must be at least 20 business days after the holder is given the notice.

### **<sup>4</sup> Notice of decision**

The administering authority must give the EA holder a notice about the decision within 10 business days after the amendment decision is made.

## **13. Cancellation or suspension of an EA (by administering authority)**

The administering authority can initiate a process to cancel, suspend or extend the suspension of an EA (the proposed action) under the circumstances outlined in s. 278. Some examples of these circumstances are:

- where the EA holder, after the giving of the EA, is convicted of an environmental offence
- the EA holder has been given an annual notice, audit notice or surrender notice and the notice has not been complied with
- the EA holder has not provided the required amount of financial assurance
- the EA holder has failed to comply with a requirement to provide surety or a contribution to the scheme manager
- if a PRCP schedule applies for carrying out the relevant activities under the environmental authority, the holder has failed to comply with the schedule
- cancellation of a suspended EA when the annual fee has not been paid

The holder of the EA must be given details of the proposed action and allowed an opportunity to make written representations about the proposed action. After considering any written representation the administering authority must decide whether or not to take the proposed action. If grounds exist to take the proposed action, the decision may be to cancel the EA or suspend it for a fixed period or extend the suspension for a fixed period. The holder must be advised of the decision by written notice.

Under section 278B, the suspension of an EA (after 5 April 2023) does not affect the continued application of the following provisions relating to the EA holder:

- a) Cancellation and suspension of EAs (Chapter 5, part 11, division 1)
- b) Amendments by the administering authority (Chapter 5, part 6)
- c) Surrender of EAs (Chapter 5, part 10)
- d) Claiming assurance (Chapter 5, part 14, division 3)
- e) Environmental evaluations, transitional environmental programs, temporary emissions licences, environmental protection orders, direction notices, clean-up notices and cost recovery notices (Chapter 7, parts 2 to 5C)
- f) Offences relating to environmental requirements (Chapter 8, part 2)

Figure 19 outlines this process for cancellation or suspension of an EA by the administering authority.

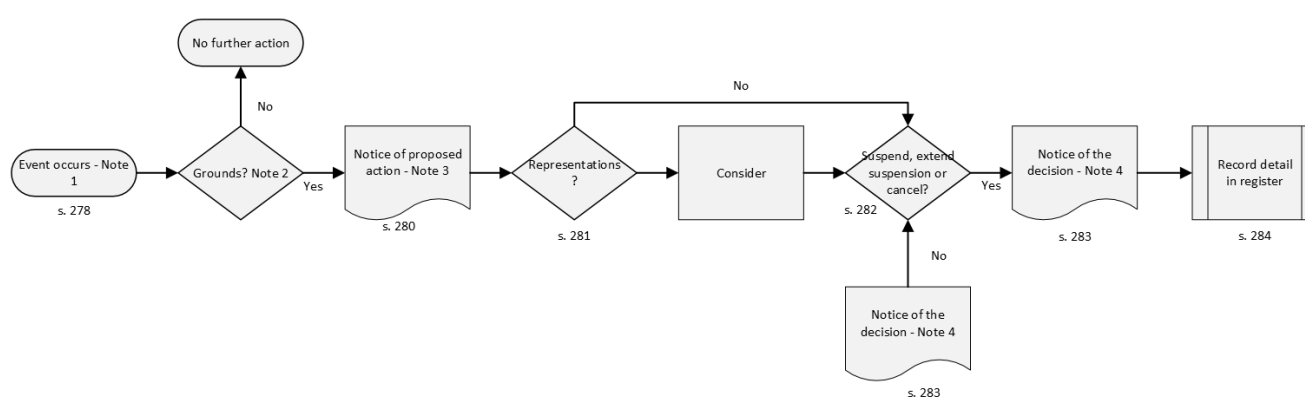

**Figure 19: EA cancellation or suspension process by the administering authority**

### Notes:

#### <sup>1</sup> Events

The administering authority may cancel, suspend an EA or extend the suspension of an EA if an event stipulated under s. 278(2) has occurred.

#### <sup>2</sup> Grounds for proposing to suspend or cancel EA

The administering authority will consider the severity of the event, the likelihood of further environmental offences and the public interest in deciding whether to propose cancellation, suspension or extension of the suspension of the EA.

#### <sup>3</sup> Notice of proposed action

The notice of proposed action must state:

- \* the action (suspend, extension of the suspension or cancel) proposed to be taken
- \* the grounds for the action
- \* the facts and circumstances that are the basis of the grounds
- \* the proposed suspension period or extension of suspension period (if applicable)
- \* that the operator may make, within a stated period, written representations.

The timeframe stated for the EA holder to make representations must be at least 20 business days after the holder is given the notice.

#### <sup>4</sup> Notice of proposed action decision

The administering authority must give the EA holder a notice about the decision within 10 business days after the proposed action decision is made. The decision takes effect either on the day the notice is given to the holder or a later day if stated in the notice. If the EA is for a resource activity, then the administering authority must also send a notice to the chief executive administering the resource legislation.



## 14. Cancellation or suspension of a suitable operator registration

DESI as the chief executive can initiate a process to cancel or suspend a suitable operator's registration (the proposed action) where:

- a disqualifying event has happened
- the chief executive is satisfied the operator is not suitable to be a RSO

The suitable operator must be given details of the proposed action and allowed an opportunity to make written representations about the proposed action. After considering any written representation the chief executive must decide whether or not to take the proposed action. The suitable operator must be advised of the decision.

Figure 20 outlines the process for cancellation or suspension of a suitable operator registration.

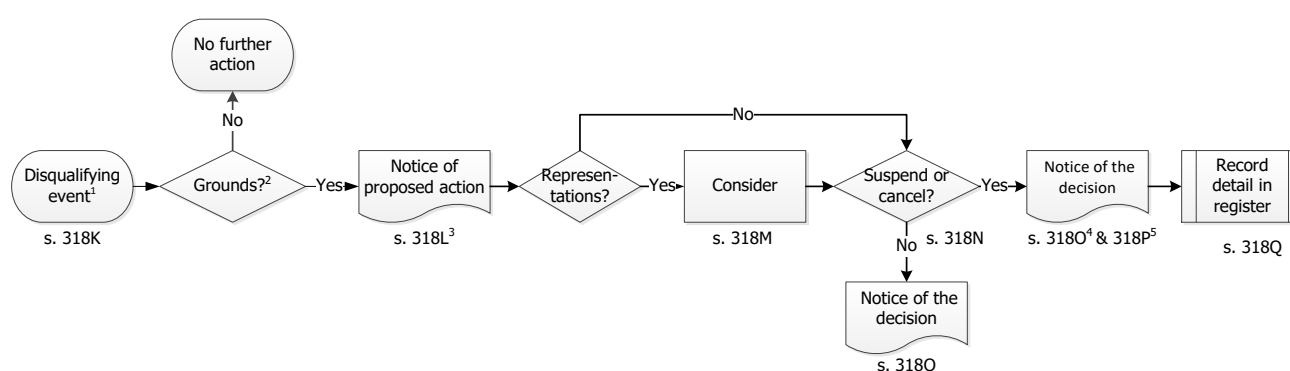

Figure 20: Cancellation or suspension of a suitable operator registration

### Notes:

#### <sup>1</sup> Disqualifying events

The chief executive may cancel or suspend a registration if a disqualifying event has happened to:

- \* the suitable operator
- \* another person of whom the operator is a partner
- \* any of the corporation's executive officers
- \* another corporation where any of the operator's corporation are, or have been executive officers.

A disqualifying event is defined in Schedule 4 of the EP Act.

#### <sup>2</sup> Grounds for proposing to suspend or cancel registration

The chief executive will consider the severity of the disqualifying event, the likelihood of further environmental offences and the public interest in deciding whether to propose cancellation or suspension of the registration.

#### <sup>3</sup> Notice of proposed action

The notice of proposed action must state:

- \* the action (suspend or cancel) proposed to be taken
- \* the grounds for the action
- \* the facts and circumstances
- \* the proposed suspension period (if applicable)
- \* that the operator may make, within a stated period, written representations as to why the proposed action should not be taken.

The timeframe stated for the suitable operator to make representations must be at least 20 business days after the operator is given the notice.

#### <sup>4</sup> Notice of decision

The chief executive must give the EA holder written notice of the decision within 10 business days after the proposed action decision is made. If the decision is to cancel or suspend the EA the written notice to the EA holder must be an information notice giving details of the decision, the reasons for the decision and the review or appeal details. If the operator is the holder of an EA for a resource activity, then the chief executive must also give written notice of the decision to the chief executive administering the resource legislation.

**<sup>5</sup> When decision takes effect**

A decision to cancel or suspend the EA takes effect either on the day the information notice is given or a later day if stated in the notice.

## 15. Internal review of decisions and appeals

Original decisions as outlined in Schedule 2 of the EP Act may be internally reviewed by application.

Applications must be made by a dissatisfied person as outlined under s. 520. A dissatisfied person includes, but is not limited to:

- the applicant for a decision about an EA application
- any submitter for a site-specific application for an EA for a petroleum activity
- the applicant for an application for registration as a suitable operator.

The application must be in the approved form and be made to the administering authority within the *review application period*, which is 10 business days after the original decision notice is received or the day the administering authority is taken to have made the decision (*the review date*). In special circumstances the administering authority may allow a longer period. The application must also be supported by enough information to enable the administering authority to decide the application.

Where an internal review of decision is applied for, the administering authority must send a notice of the application (*the review notice*) and a copy of the application and supporting documents or details of where a copy of the application and supporting documents may be inspected or accessed, to all other persons who received the original decision notice. This must be done within 5 business days after the end of the review application period (or the latest of the review application periods if 2 or more review applications are received). The review notice must inform the recipient that submissions on the application may be made to the administering authority within five business days after the authority sends the review notice to the recipient.

The administering authority must review the original decision and consider any submissions made by recipients of the review notice. The decision (*the review decision*) may be to confirm, revoke or vary the original decision. The review decision period is either 15 or 20 business days after the application is received<sup>5</sup>, depending on the number of applications made and whether a submission has been received. The administering authority may decide to extend the decision period by up to 5 business days in special circumstances. A notice about the review decision must be issued to the applicant and any recipients of the review notice within 10 business days after the decision is made. The notice must include the reasons for the review decision and include information about the right of appeal.

The original decision still has effect if an application for review is made. If an internal review application is made for an original decision, other than an original decision outlined in Schedule 2, Part 3 of the EP Act) the applicant may immediately apply for a stay of a decision to either the Land Court (for original decisions as outlined in Schedule 2, Part 1 of the EP Act) or the Planning and Environment Court (for original decisions as

---

<sup>5</sup> Refer section 521(15) of the EP Act.

## Approval processes for environmental authorities

---

outlined in Schedule 2, Part 2 of the EP Act). A stay may be given on a decision or condition considered appropriate for a stated period. This effectively stops or halts the decision or condition until the stated period ends.

A dissatisfied person may make an appeal on a review decision in certain circumstance to either the Land Court (for original decisions as outlined in Schedule 2, Part 1 of the EP Act) under s. 524 or the Planning and Environment Court (for original decisions as outlined in Schedule 2, Part 1 of the EP Act) under s. 531. For further information on appeal process please refer to:

- the Land Court website at: <http://www.landcourt.qld.gov.au/>
- the Planning and Environment Court website at: <http://www.courts.qld.gov.au/courts/planning-and-environment-court>

An appeal against a decision does not affect the operation or carrying out of the decision unless the decision is stayed. The relevant Court may grant a stay on a decision or condition considered appropriate for a stated period. The period of a stay must not extend past the time when the relevant Court decides the appeal.

## Version history

Version	Date	Description of changes
1.00	21 February 2014	Original externally published document
2.00	23 June 2015	Legislative amendments introduced through the <i>Environmental Protection and Other Legislation Amendment Bill 2014</i>
3.00	19 July 2016	Added a new section - When an EA takes effect
4.00	12 September 2016	Removed note 5 from figure 15.
4.01	3 July 2017	Replaced <i>Sustainable Planning Act 2009</i> with <i>Planning Act 2016</i> .
4.02	11 June 2018	Document rebranded to align with machinery of government changes
4.03	8 October 2019	Updated for the Environmental Protection Regulation 2019.
5.00	1 November 2019	Updated to reflect the commencement of the progressive rehabilitation and closure plan framework under the <i>Mineral and Energy Resources (Financial Provisioning) Act 2018</i> and the subsequent changes to the <i>Environmental Protection Act 1994</i> .
6.00	1 December 2020	Updated to reflect the changes to the <i>Environmental Protection Act 1994</i> as a result of the <i>Environmental Protection and Other Legislation Amendment Act 2020</i> .
7.00	8 January 2021	Clarified that an agricultural ERA does not require an EA. Updated to replace Department of Natural Resources, Mines and Energy with Department of Resources and delete reference to section 84(4)(b) of the <i>State Development and Public Works Organisation Act 1971</i> from section 4 of the guideline.
7.01	17 December 2021	Added in reference to the guideline Approval process maps for environmental authorities [ESR/2021/5884] as a supporting document and some changes to reflect new document formatting.
8.00	3 May 2023	Document updated to align with the <i>Environmental Protection and Other Legislation Amendment Act 2023</i> .
8.01	14 February 2024	Document rebranded to align with machinery of government changes